

Rue de la Croix du Maître 26 - 7110 Strey-Bracquenies
info@masquelieraciers.be
www.masquelieraciers.be

Ces pages vous donneront une idée de la gamme des produits que nous tenons à votre disposition. Nous pouvons vous aider et vous conseiller techniquement aussi. Nos livraisons sont exécutées rapidement par nos camions grues.

Certifiés par la norme européenne obligatoire **EN1090**, nous sommes dès lors en mesure de vous offrir, conformément à la loi, tous types de parachèvements :

- le sciage,
- le forage,
- l'oxycoupage,
- le pliage,
- le cisailage,
- la soudure,
- le coupage et façonnage d'armatures,
- le sablage,
- le grenailage,
- la peinture,
- la galvanisation, etc...

Nos dépôts sont certifiés Benor pour le stockage et la fourniture de ronds à béton et treillis soudés.

Les informations contenues dans ce livret vous sont données à titre indicatif et sans engagement de notre part.

Nos services se tiennent à votre entière disposition pour vous conseiller de manière judicieuse dans le choix des produits dont vous auriez besoin.

De plus, vous bénéficiez à travers nos services d'un bureau des méthodes de fabrication dont le rôle principal, en plus du conseil, est la retranscription de vos schémas et plans divers en plans d'exécution selon les critères de qualité de la norme européenne EN1090.

Toujours à votre service,
La Direction.



Sommaire

■ Produits à béton	2
■ Poutrelles	7
■ Aciers Marchands	22
■ Tôles	28
■ Métal déployé	30
■ Tubes carrés et rectangulaires	31
■ Tubes ronds	33
■ Moulurés à Froid	34
■ Fontes	35
■ Caillebotis	40
■ Divers - Accessoires	41

Rond à béton

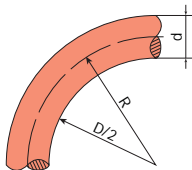
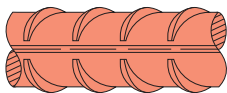

Crénelé : BE 500 S

d	Section mm ²	Kg/m
6	28,3	0,23
8	50,3	0,40
10	78,5	0,63
12	113,1	0,90
14	153,9	1,23
16	201,1	1,61
20	314,2	2,51
25	490,9	3,93
28	615,8	4,93
32	804,3	6,43
40	1256,6	10,05

Plié coupé sur demande

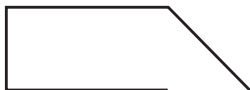

Treillis soudés

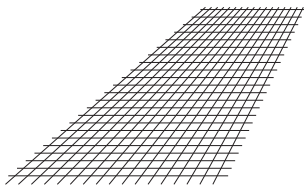

Treillis d'armatures à mailles soudées DE500BS fils nervurés

Treillis standard 5,00 m x 2,00 m

Fils	Mailles carrées				
	200 x 200	150 x 150	100 x 100	75 x 75	50 x 50*
4 mm		13,22 Kg	20,08 Kg		40,0 Kg
5 mm	15,69 Kg	20,56 Kg	31,39 Kg	42,22 Kg	
6 mm	22,62 Kg	29,64 Kg	45,25 Kg		
8 mm	40,25 Kg	52,74 Kg	80,51 Kg		
10 mm	62,88 Kg	82,37 Kg	125,76 Kg		
12 mm	90,50 Kg	118,55 Kg	180,99 Kg		

* Fil lisse (non nervuré)

Egalement disponible en format 2,00 m x 1,00 m

150 x 150 x 5 mm

Treillis avec côtés ouverts 5.95 m X 2.35 m

Fils	Mailles carrées
	150 x 150
6 mm	39,08 Kg/panneau
8 mm	66,05Kg/panneau
10 mm	103,34 Kg/panneau
12 mm	141,18 Kg/panneau

Films Polyéthylène

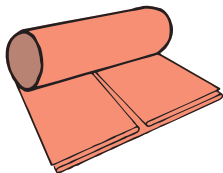

	Ep.	Larg.	Long.	Kg.
	0,10 mm	2 m	50 m	10
	0,10 mm	4 m	50 m	20
	0,10 mm	6 m	50 m	30
	0,20 mm	2 m	50 m	20
	0,20 mm	4 m	50 m	40
	0,20 mm	6 m	50 m	60

Fils à ligaturer

Fil recuit (roul. de 5 et 25 Kg)

BWG**	Ø	
N° 8	4,20 mm	109 Kg/1000m
N° 11	3,05 mm	57 Kg/1000m
N° 14	2,10 mm	27 Kg/1000m
N° 17	1,45 mm	13 Kg/1000m
N° 18	1,25 mm	9 Kg/1000m

** (Birmingham Wire Gauge)

Ligatures à œillets

Article	p/Box
Fil L = 80 mm	1000
Fil L = 100 mm	1000
Fil L = 120 mm	1000
Fil L = 140 mm	1000
Fil L = 160 mm	1000
Fil L = 180 mm	1000

Vrilleuse

Article	p/Box
Vrilleuse	1

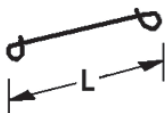

Ecarteurs PVC et Béton



Ecarteurs PVC pour armatures horizontales

H mm	Ø mm	p/Box	Kg/100
25	6-14	500	0,49
30	6-16	250	0,63



Ecarteurs PVC pour armatures verticales

E mm	Ø mm	p/Box	Kg/100
25	4-12	500	0,61
30	4-12	250	0,85



Réglette PVC

H mm	m/Pal	m/Box	Kg/m
30	3500	100	0,19

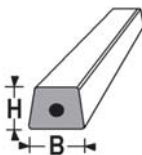

Réglettes trapezoïdales en béton L = 1 m

H mm	B mm	Kg/m
30	35	1,92
40	40	3,18

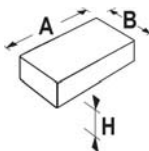

Dallettes béton

H mm	AxB mm	Kg/1
30	140 x 70	0,70
40	190 x 70	1,19

Ecarteurs

Chaises Type A - L = 2 m

H cm	Kg/m
6	0,45
8	0,47
10	0,49
12	0,51
15	0,54
18	0,58
20	0,61
24	0,73

Chaises Zig Zag - L = 2 m

H cm	Kg/m
6	0,30
8	0,33
10	0,37
12	0,39
15	0,48
18	0,55
20	0,56
24	0,68

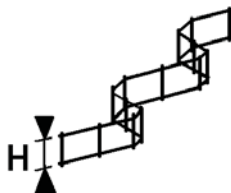
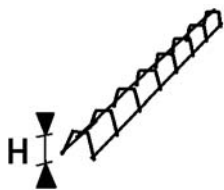

Profils normaux - UPN

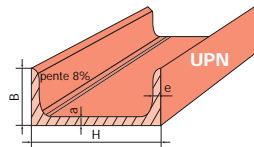

H mm	B mm	a mm	e mm	Kg / m
80	45	6,0	8,0	8,80
100	50	6,0	8,5	10,80
120	55	7,0	9,0	13,60
140	60	7,0	10,0	16,32
160	65	7,5	10,5	19,20
180	70	8,0	11,0	22,40
200	75	8,5	11,5	25,76
220	80	9,0	12,5	29,92
240	85	9,5	13,0	33,84
260	90	10,0	14,0	38,63
280	95	10,0	15,0	42,64
300	100	10,0	16,0	47,04

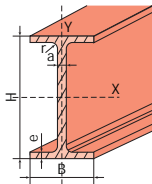

Poutrelles I Européennes IPE

Profils Européens.

IPE	Kg / m	H	B	a	e	S cm ²	I _x cm ⁴	W _x cm ³
80	6,11	80	46	3,8	5,2	7,64	80,14	20,03
100	8,26	100	55	4,1	5,7	10,32	171	34,2
120	10,57	120	64	4,4	6,3	13,21	317,8	52,96
140	13,14	140	73	4,7	6,9	16,43	541,2	77,32
160	16,07	160	82	5,0	7,4	20,09	869,3	108,7
180	19,16	180	91	5,3	8,0	23,95	1317	146,3
200	22,79	200	100	5,6	8,5	28,48	1943	194,3
220	26,70	220	110	5,9	9,2	33,37	2772	252
240	31,29	240	120	6,2	9,8	39,12	3892	324,3
270	36,76	270	135	6,6	10,2	45,95	5790	428,9
300	43,05	300	150	7,1	10,7	53,81	8356	557,1
330	50,08	330	160	7,5	11,5	62,61	11770	713,1
360	58,18	360	170	8,0	12,7	72,73	16270	903,6
400	67,57	400	180	8,6	13,5	84,46	23130	1156
450	79,06	450	190	9,4	14,6	98,82	33740	1500
500	92,42	500	200	10,2	16,0	115,52	48200	1928
550	107,53	550	210	11,1	17,2	134,42	67120	2441
600	124,79	600	220	12,0	19,0	155,98	92080	3069

Table des charges admissibles en flexion →

Charges uniformément réparties que peuvent porter les poutrelles non compris leur poids propre, l'acier travaillant à 12 kgs par mm².

IPE	Kg/ m	2	3	4	5	6	7	8	9	10	11	12
80	6,2	948	622	456								
100	8,3	1625	1070	788	617							
120	10,6	2523	1665	1230	966	786						
140	13,2	3684	2434	1803	1419	1159	969					
160	16,1	5200	3441	2553	2014	1649	1385	1182				
180	19,2	6970	4616	3429	2709	2223	1870	1602	1388			
200	22,9	9267	6141	4566	3613	2970	2503	2149	1867	1638		
220	26,7	12000	7990	5940	4710	3880	3270	2810	2450	2160	1910	1700
240	31,3	15490	10276	7653	6037	5000	4228	3642	3180	2803	2490	2224
270	36,8	20520	13620	10150	8056	6648	5630	4860	4250	3757	3347	3000
300	43,1	26652	17697	13200	10484	8660	7344	6346	5562	4925	4397	3950
330	50,1	34126	22670	16915	13444	11114	9435	8163	7163	6354	5682	5115
360	58,2	43278	28757	21468	17071	14121	11997	10391	9129	8107	7261	6547
400	67,6	55547	36921	27575	21940	18162	15444	13390	11777	10473	9394	8484
450	79,1	71800	47800	35700	28400	23500	20000	17400	15300	13600	12200	11000
500	92,5	92500	61500	46000	36600	30300	25800	22400	19800	17600	15800	14400
550	108,1	117000	77800	58100	46300	38400	32700	28400	25100	22400	20100	18200
600	124,1	147000	97900	73200	58300	48400	41200	35900	31600	28300	25500	23100

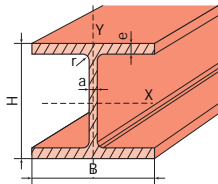

Poutrelles HEA

Poutrelles à larges ailes HEA.

HEA	Kg / m	H	B	a	e	A cm ²	I _x cm ⁴	W _x cm ³
100	16,99	96	100	5,0	8,0	21,24	349,2	72,76
120	20,27	114	120	5,0	8,0	25,34	606,2	106,3
140	25,13	133	140	5,5	8,5	31,42	1033	155,4
160	31,02	152	160	6,0	9,0	38,77	1673	220,1
180	36,20	171	180	6,0	9,5	45,25	2510	293,6
200	43,06	190	200	6,5	10,0	53,83	3692	388,6
220	51,47	210	220	7,0	11,0	64,34	5410	515,2
240	61,47	230	240	7,5	12,0	76,84	7763	675,1
260	69,46	250	260	7,5	12,5	86,82	10450	836,4
280	77,81	270	280	8,0	13,0	97,26	13670	1013
300	90,02	290	300	8,5	14,0	112,53	18260	1260
320	99,49	310	300	9,0	15,5	124,37	22930	1479
340	106,78	330	300	9,5	16,5	133,47	27690	1678
360	114,21	350	300	10,0	17,5	142,76	33090	1891
400	127,18	390	300	11,0	19,0	158,98	45070	2311
450	142,42	440	300	11,5	21,0	178,03	63720	2896
500	158,03	490	300	12,0	23,0	197,54	86970	3550
550	169,41	540	300	12,5	24,0	211,76	111900	4146
600	181,17	590	300	13,0	25,0	226,46	141200	4787
650	193,31	640	300	13,5	26,0	241,64	175200	5474
700	208,38	690	300	14,5	27,0	260,48	215300	6241
800	228,66	790	300	15,0	28,0	285,83	303400	7682
900	256,42	890	300	16,0	30,0	320,53	422100	9485
1000	277,48	990	300	16,5	31,0	346,85	553800	11190

Table des charges admissibles en flexion →

Charges uniformément réparties que peuvent porter les poutrelles non compris leur poids propre, l'acier travaillant à 12 kgs par mm².

HEA	Kg / m	2	2,5	3	3,5	4	5	6	7	8	9	10	11	12
100	17,1	3470	2761	2285	1943									
120	20,3	5048	4020	3332	2837									
140	25,2	7390	5890	4885	4164	3261	2852							
160	31	10499	8372	6948	6127	5158	4072							
180	36,2	14014	11200	9301	7939	6914	5467	4491						
200	43,2	18587	14831	12321	10521	9166	7257	5970	5038					
220	51,5	24619	19649	16328	13948	12158	9635	7937	6709					
240	61,5	32279	25769	21419	18303	15958	12658	10438	8835	7617				
260	69,5		31931	26547	22691	19791	15710	12966	11174	9486				
280	77,9		38593	32190	27435	23934	19010	15701	13316	11508	10085			
300	90			40055	34250	29886	23750	19630	16661	14413	12645			
320	99,5			47067	40252	35129	27928	23094	19613	16979	14907	13232		
340	107,1			53445	45665	39900	31731	26250	22281	19320	16963	15078	13461	11280
360	114,2			60144	51394	44912	35728	29568	25109	21784	19139	17024	15211	13776
400	127,4					54940	43727	36210	30772	26720	23499	20926	18722	16980
450	142,7					69040	54980	45560	38750	33680	29654	26400	23690	21520
500	158					84580	67405	55870	47550	41360	36448	32530	29180	26540
550	169,2					98936	78850	65404	55693	48472	42745	38180	34279	31208
600	181,4						91078	75572	64377	56056	49459	44204	39715	36184
650	193,7						104074	86380	73609	64120	56600	47330	45499	41480
700	207,9						118788	98616	84060	73248	64682	57864	52048	47472
800	228,3							121536	103648	90368	79852	71488	64352	58752
900	256,9									128112	111744	98788	88488	79704
1000	277,2											132104	116837	104704
													94361	86256

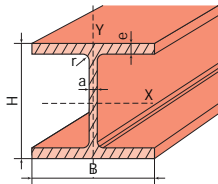

Poutrelles HEB

Poutrelles à larges ailes HEB.

HEB	Kg / m	H	B	a	e	A cm ²	I _x cm ⁴	W _x cm ³
100	20,83	100	100	6,0	10,0	26,04	449,5	89,91
120	27,20	120	120	6,5	11,0	34,01	864,4	144,1
140	34,36	140	140	7,0	12,0	42,96	1509	215,6
160	43,40	160	160	8,0	13,0	54,25	2492	311,5
180	52,20	180	180	8,5	14,0	65,25	3831	425,7
200	62,46	200	200	9,0	15,0	78,08	5696	569,6
220	72,83	220	220	9,5	16,0	91,04	8091	735,5
240	84,79	240	240	10,0	17,0	105,99	11260	938,3
260	94,76	260	260	10,0	17,5	118,44	14920	1148
280	105,09	280	280	10,5	18,0	131,36	19270	1376
300	119,26	300	300	11,0	19,0	149,08	25170	1678
320	129,07	320	320	11,5	20,5	161,34	30820	1926
340	136,72	340	300	12,0	21,5	170,90	36660	2156
360	144,51	360	300	12,5	22,5	180,63	43190	2400
400	158,22	400	300	13,5	24,0	197,78	57680	2884
450	174,38	450	300	14,0	26,0	217,98	79890	3551
500	190,91	500	300	14,5	28,0	238,64	107200	4287
550	203,25	550	300	15,0	29,0	254,06	136700	4971
600	215,97	600	300	15,5	30,0	269,96	171000	5701
650	229,07	650	300	16,0	31,0	286,34	210600	6480
700	245,10	700	300	17,0	32,0	306,38	256900	7340
800	267,34	800	300	17,5	33,0	334,18	359100	8977
900	297,02	900	300	18,5	35,0	371,28	494100	10980
1000	320,04	1000	300	19,0	36,0	400,05	644700	12890

Table des charges admissibles en flexion →

Charges uniformément réparties que peuvent porter les poutrelles non compris leur poids propre, l'acier travaillant à 12 kgs par mm².

HEB	Kg / m	2	2,5	3	3,5	4	5	6	7	8	9	10	11	12
100	20,8	4279	3405	2818	2394	2078								
120	27,3	6858	5462	4528	3851	3349								
140	34,4	10300	8209	6810	5800	5049	3978							
160	43,5	14842	11835	9824	8372	7293	5758							
180	52,2	20345	16230	13478	11492	10024	7974	6606						
200	62,5	27237	21734	18056	15403	13434	10637	8752	7379					
220	72,9	35185	28083	23337	19915	17378	13773	11347	9582					
240	84,8	44857	35811	29766	25409	22179	17593	14508	12267	10590				
260	94,8		43927	36521	31184	27228	21615	17842	15104	13056				
280	105		52734	43851	37451	32708	25981	21462	18185	15736	13783			
300	119,3			53409	45622	39852	31671	26178	22197	19224	16855			
320	129,5			61379	52437	45812	36421	30118	25552	22144	19430	17258		
340	136,6			68718	58715	51304	40802	33756	28654	24848	21819	19396	17318	
360	144,8			76374	65263	57032	45370	37548	31886	27664	24306	21620	19318	
400	158				68500	54521	45150	38371	33320	29305	26098	23351	21180	
450	174,3				84516	67305	55774	47438	41232	36304	32370	29005	26348	
500	190,6				102212	81433	67518	57464	49984	44048	39314	35266	32076	
550	202,8				118484	94429	78326	66696	58048	51189	45722	41050	37372	
600	216,1					108380	89928	76606	66704	58854	52600	47258	43056	
650	229,3					123291	102330	87201	75960	67051	59958	53901	49140	
700	245,6					139723	115994	102245	86152	76075	68054	61207	55828	
800	267						142108	121192	105664	93368	83588	75244	68696	
900	296,6							148389	129432	114427	102498	92325	84348	
1000	320								152168	134581	120604	108689	99352	

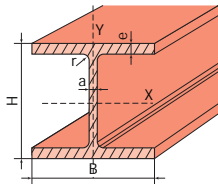

Poutrelles HEM

Poutrelles à larges ailes HEM.

HEM	Kg / m	H	B	a	e	A cm ²	I _x cm ⁴	W _x cm ³
100	42,59	120	106	12,0	20,0	53,24	1143	190,4
120	53,12	140	126	12,5	21,0	66,41	2018	288,2
140	64,44	160	146	13,0	22,0	80,56	3291	411,4
160	77,64	180	166	14,0	23,0	97,05	5098	566,5
180	90,60	200	186	14,5	24,0	113,25	7483	748,3
200	105,02	220	206	15,0	25,0	131,28	10640	967,4
220	119,55	240	226	15,5	26,0	149,44	14600	1217
240	159,67	270	248	18,0	32,0	199,59	24290	1799
260	175,72	290	268	18,0	32,5	219,64	31310	2159
280	192,13	310	288	18,5	33,0	240,16	39550	2551
300	242,46	340	310	21,0	39,0	303,08	59200	3482
320	249,64	359	309	21,0	40,0	312,05	68130	3796
340	252,66	377	309	21,0	40,0	315,83	76370	4052
360	255,05	395	308	21,0	40,0	318,81	84870	4297
400	260,62	432	307	21,0	40,0	325,78	104100	4820
450	268,35	478	307	21,0	40,0	335,44	131500	5501
500	275,44	524	306	21,0	40,0	344,30	161900	6180
550	283,50	572	306	21,0	40,0	354,38	198000	6923
600	290,93	620	305	21,0	40,0	363,66	237400	7660
650	298,99	668	305	21,0	40,0	373,74	281700	8433
700	306,41	716	304	21,0	40,0	383,02	329300	9198
800	323,41	814	303	21,0	40,0	404,27	442600	10870
900	338,90	910	302	21,0	40,0	423,63	570400	12540
1000	355,36	1008	302	21,0	40,0	444,21	722300	14330

Table des charges admissibles en flexion →

Charges uniformément réparties que peuvent porter les poutrelles non compris leur poids propre, l'acier travaillant à 12 kgs par mm².

HEM	Kg / m	2	2,5	3	3,5	4	5	6	7	8	9	10	11	12
100	42,6	9036	7191	5954	5059	4398								
120	53,1	13719	10928	9059	7708	6703								
140	64,5	19601	15624	12962	11039	9611	7575							
160	77,8	27015	21543	17883	15241	13279	10486							
180	90,6	35726	28500	23669	20183	17596	13916	11434						
200	108	46210	36874	30635	26134	22796	18051	14854	12526					
220	119,3	58326	46555	38689	33018	28812	22839	18818	15895					
240	160	86086	68727	57129	48770	42572	33775	27858	23561	20344				
260	175,3		82514	68604	58582	51152	40612	33528	28388	24544				
280	192,7		97447	81033	69208	60444	48015	39666	33612	29088	25482			
300	242,6			110646	94519	82568	65626	54252	46010	39856	34954	31028		
320	249,7			120865	103262	90220	71735	59330	50345	43640	38303	34030		
340	252,8			128856	110102	96208	76520	63312	53749	46616	40941	36400	32507	
360	254,8			136850	116945	102200	81310	67300	57160	49600	43588	38780	34660	31400
400	260,9					114656	91264	75584	64245	55792	49077	43712	39118	35488
450	268,1					130948	104285	86422	73509	63896	56263	50170	44957	40844
500	275,2					147240	117306	97260	82776	72000	63448	56628	50796	46200
550	283,4					164968	131474	109052	92858	80816	71265	63652	57146	52024
600	290,5						145647	120850	102947	89640	79090	70686	63507	57860
650	298,6						160391	133122	113440	98816	87226	77998	70118	63924
700	306,8						175135	145394	123933	107992	95363	85310	76729	69988
800	323,1							172018	146700	127904	113021	101182	91082	83156
900	339,4								169467	147816	130679	117054	105435	96324
1000	355,7									169168	149616	134078	120832	110452

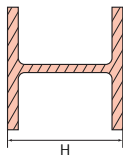

Coupes biaisés horizontaux poutrelles I et H

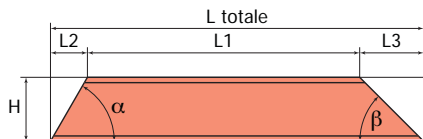
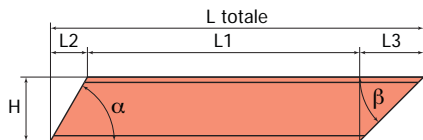
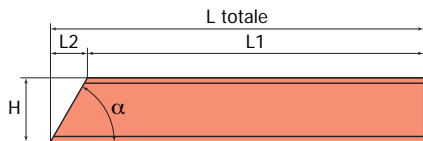

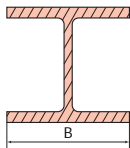

Coupes biaisées verticales poutrelles I et H

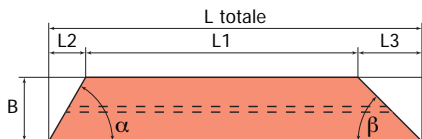
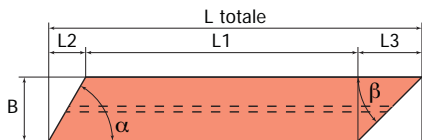
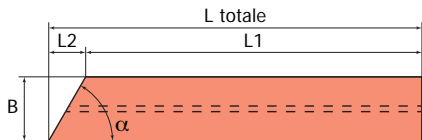

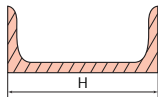

Coupes biaisés horizontales poutrelles U ouvert

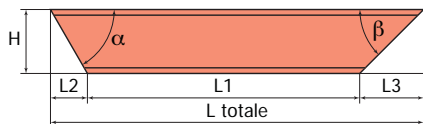
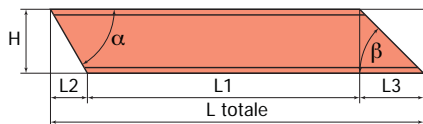
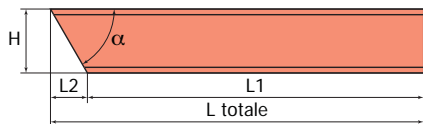

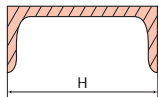

Coupes biaisées horizontales poutrelles U fermé

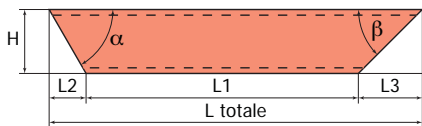
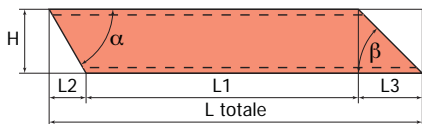
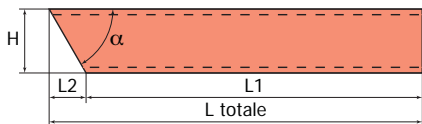

Coupes biaisées verticales poutrelles U ouvert côté droit

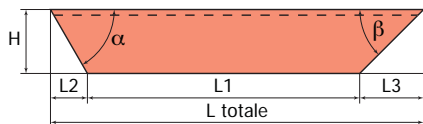
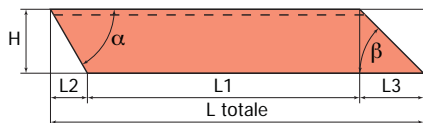
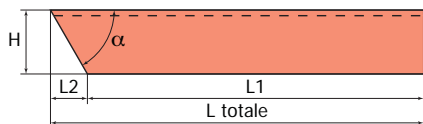
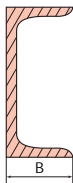

Coupes biaisées verticales poutrelles U ouvert côté gauche

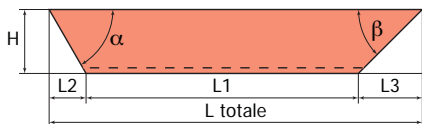
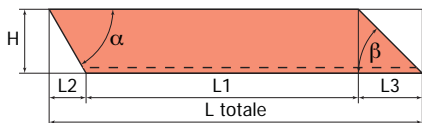
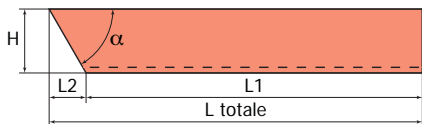
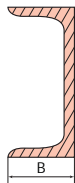

Acier Marchand - Plat

Larg. en mm	Poids					
	3	4	5	6	8	épaisseur 10
10	0,24	0,32	0,40			
12	0,29	0,38	0,48	0,58	0,75	
15	0,36	0,48	0,60	0,72	0,97	1,20
20	0,48	0,64	0,80	0,96	1,28	1,60
25	0,60	0,80	1,00	1,20	1,60	2,00
30	0,72	0,96	1,20	1,44	1,92	2,40
35	0,84	1,12	1,40	1,68	2,24	2,80
40	0,96	1,28	1,60	1,92	2,56	3,20
45	1,08	1,44	1,80	2,16	2,88	3,60
50	1,20	1,60	2,00	2,40	3,20	4,00
60	1,44	1,92	2,40	2,88	3,84	4,80
70	1,68	2,24	2,80	3,36	4,48	5,60
80		2,56	3,20	3,84	5,12	6,40
90			3,60	4,32	5,76	7,20
100	2,40	3,20	4,00	4,80	6,40	8,00
120	2,88	3,84	4,80	5,76	7,68	9,60
130			5,20	6,24	8,32	10,40
140			5,60	6,72	8,96	11,20
150	3,60	4,80	6,00	7,20	9,60	12,00
160		5,14	6,40	7,68	10,24	12,80
180			7,20	8,64	11,52	14,40
200			8,00	9,60	12,80	16,00
250					16,00	20,00
300						24,00

En gras : plats de dimensions courantes - En italique : les moins courantes

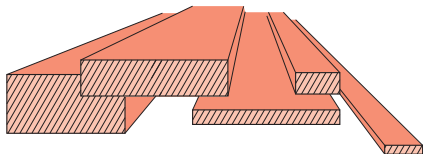

Kg/m							
r en mm							
12	15	20	25	30	40	50	
1,92	2,40						
2,40	3,00						
2,88	3,60	4,80	6,00				
3,36	4,20	5,60	7,00				
3,84	4,80	6,40	8,00	9,60			
4,32	5,40	7,20	9,00				
4,80	6,00	8,00	10,00	12,00	16,00		
5,76	7,20	9,60	12,00	14,40	19,20	24,00	
6,72	8,40	11,20	14,00	16,80	22,40	28,00	
7,68	9,60	12,80	16,00	19,20	25,60	32,00	
8,64	10,80	14,40	18,00	21,60	28,80	36,00	
9,60	12,00	16,00	20,00	24,10	32,00	40,00	
11,52	14,40	19,20	24,00	28,80	38,40	48,00	
12,48	15,60	20,80	26,00	31,20	41,60	52,00	
13,44	16,80	22,40	28,00	33,60	44,80	56,00	
14,40	18,00	24,00	30,00	36,00	48,00	60,00	
15,36	19,20	25,60	32,00	38,40			
17,28	21,60	28,80	36,00	43,20	57,60		
19,20	24,00	32,00	40,00	48,00	64,00		
24,00	30,00	40,00	50,00	60,00	80,00		
28,80	36,00	48,00	60,00	72,00			

Aciers Marchands Ronds et Carrés

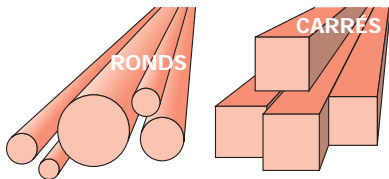

Diamètre mm	Kg / m Ronds	Kg / m Carrés	Diamètre mm	Kg / m Ronds	Kg / m Carrés
6	0,23	0,29	40	10,05	12,80
8	0,40	0,51	50	15,71	20,00
10	0,63	0,80	60	22,62	28,80
12	0,90	1,15	70	30,79	39,20
14	1,23	1,57	80	40,21	51,20
15	1,41	1,80	90	50,89	64,80
16	1,61	2,05	100	62,83	80,00
18	2,04	2,59	110	76,03	96,80
20	2,51	3,20	120	90,48	115,20
22	3,04	3,87	130	106,19	136,00
25	3,93	5,00	140	123,15	156,80
30	5,65	7,20	150	141,37	180,00
35	7,70	9,80	160	160,85	204,80

Aciers Marchands

Fers "T" et Petits "U"

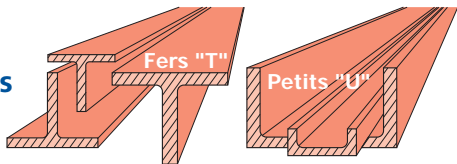

FERS "T"		PETITS FERS "U"	
Dimensions "T"	Kg/m	Dimensions "U"	Kg/m
20 x 20 x 3	0,90	30 x 15 x 4	1,77
25 x 25 x 4	1,31	40 x 20 x 5	2,93
30 x 30 x 4	1,80	40 x 35 x 5	4,97
35 x 35 x 5	2,38	50 x 25 x 5	3,94
40 x 40 x 5	3,02	50 x 38 x 5	5,70
45 x 45 x 6	3,74	60 x 30 x 6	5,17
50 x 50 x 6	4,53	65 x 42 x 5,5	7,22
60 x 60 x 7	6,35		
70 x 70 x 8	8,48		
80 x 80 x 9	10,88		
100 x 100 x 11	16,72		

Aciers Marchands Cornières

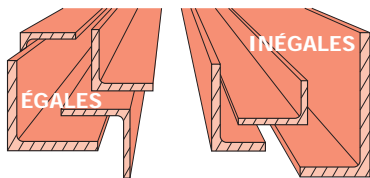

Dimensions en mm	Poids Kg/m	Dimensions en mm	Poids Kg/m
15 x 15 x 3	0,70	100 x 100 x 10	15,32
20 x 20 x 3	0,90	100 x 100 x 12	18,17
25 x 25 x 3	1,14	120 x 120 x 10	18,55
25 x 25 x 4	1,48	120 x 120 x 12	22,03
30 x 30 x 3	1,39	120 x 120 x 15	27,15
30 x 30 x 4	1,81	150 x 150 x 10	23,42
30 x 30 x 5	2,22	150 x 150 x 12	27,87
35 x 35 x 4	2,13	150 x 150 x 15	34,42
40 x 40 x 4	2,46	200 x 200 x 20	61,08
40 x 40 x 5	3,03	40 x 20 x 4	1,80
40 x 40 x 6	3,58	40 x 25 x 4	1,97
45 x 45 x 5	3,44	50 x 30 x 5	3,02
50 x 50 x 5	3,84	60 x 40 x 6	4,55
50 x 50 x 6	4,57	70 x 50 x 6	5,51
50 x 50 x 8	5,93	80 x 40 x 6	5,52
60 x 60 x 6	5,53	80 x 60 x 7	7,51
60 x 60 x 8	7,22	100 x 50 x 6	6,99
70 x 70 x 7	7,52	100 x 50 x 8	9,17
80 x 80 x 8	9,81	120 x 80 x 10	15,32
80 x 80 x 10	12,09	150 x 90 x 10	18,54
80 x 80 x 12	14,29	150 x 100 x 10	19,36
90 x 90 x 9	12,42	200 x 100 x 10	23,42

Table des charges admissibles en flexion

Charges uniformément réparties que peuvent porter les cornières non compris leur poids propre, la cornière reposant, en ses extrémités, horizontalement sur une de ses ailes, la plus petite pour les cornières inégales (l'acier travaillant à 12 kgs par mm²).

Cornières	Portées en mètres							
	0,5 m Kg	1 m Kg	1,2 m Kg	1,4 m Kg	1,6 m Kg	1,8 m Kg	2 m Kg	3 m Kg
L30 x 30 x 3	132	65	54	46	40	35	31	19
Li40 x 25 x 4	285	142	117	100	87	76	68	41
L40 x 40 x 4	307	154	126	107	93	83	74	46
L40 x 40 x 5	379	187	155	133	115	101	90	56
Li50 x 30 x 5	548	272	226	193	168	148	133	81
L50 x 50 x 5	604	300	249	212	185	163	146	92
L50 x 50 x 6	712	353	293	250	217	192	171	109
L60 x 60 x 6	1043	518	430	367	320	283	253	162
L70 x 70 x 7	1661	826	686	586	511	452	405	260
L80 x 80 x 8	2479	1234	1025	876	764	676	606	391
L90 x 90 x 9	3529	1758	1462	1249	1090	965	865	561
L100 x 100 x 10	4841	2411	2005	1715	1496	1326	1189	773
L120 x 120 x 12	7729	3854	3205	2742	2393	2121	1903	1243
L150 x 150 x 15	15321	7642	6360	5443	4753	4216	3785	2484
L200 x 200 x 20	38768	19350	16107	13790	12049	10618	9607	6328

Tôles

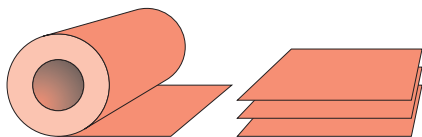

Tôle laminée à froid (LAF)

Ep ^r (mm)	Poids par tôle (Kg)		
	2000 x 1000 mm	2500 x 1250 mm	3000 x 1500 mm
0,8	13	20	29
1,0	16	25	36
1,2	20	31	45
1,5	24	38	54
2,0	32	50	72
2,5	40	63	90
3,0	48	75	108

Tôle laminée à chaud (LAC)

1,5	24	38	54
2,0	32	50	72
2,5	40	63	90
3,0	48	75	108
4,0	64	100	144
5,0	80	125	180
6,0	96	150	216
8,0	128	200	288
10,0	160	250	360
12,0	192	300	432
15,0	240	375	540
20,0	320	500	720
25,0	400	625	900
30,0	480	750	1080

Tôles spéciales



Tôle larmée

Ep (mm)	Poids par tôle (Kg)		
	2000 x 1000 mm	2500 x 1250 mm	3000 x 1500 mm
3/5	56	88	126
5/7	88	138	198
8/10	136	213	306
10/12	168	263	378

Tôle galvanisée ou electrozinguée

Ep (mm)	Poids par tôle (Kg)		
	2000 x 1000 mm	2500 x 1250 mm	3000 x 1500 mm
0,5	8		
0,6	10		
0,8	13		
1,0	16	25	36
1,5	24	38	54
2,0	32	50	72
3,0	48	75	108

Tôle ondulée galvanisée

Ondes: 76 x 18

Tôles de bardage

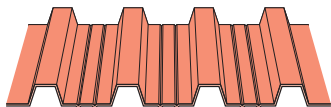

Tôles perforées

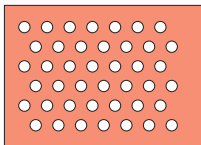

Métal déployé

A = Lanière
B = Épaisseur

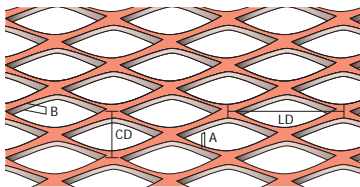

Référence	LD x CD	Lanière x épaisseur	Dimensions feuilles
6.3.08.06	6 x 3,2	0,8 x 0,6	1000 x 2000
10.5.12.10	10 x 5,2	1,2 x 1	1000 x 2000
21.10.15.15	21 x 10	1,5 x 1,5	1250 x 2500
31.14.21.15	31 x 14	2,1 x 1,5	1250 x 2500
A.31.16.23.15	31 x 16	2,3 x 1,5	1250 x 2500
51.23.32.30	51 x 23	3,2 x 3	1250 x 2500
A.51.27.35.30	51 x 27	3,5 x 3	1250 x 2500
86.40.45.40	86 x 40	4,5 x 4	1250 x 2500

Dimensions en mm.

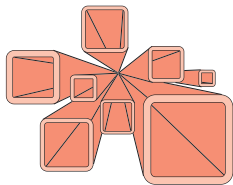

Tubes carrés

Dimensions en mm	Poids Kg/m	Dimensions en mm	Poids Kg/m
10 x 10 x 1	0,28	80 x 80 x 5	11,48
15 x 15 x 1,5	0,64	80 x 80 x 6	13,47
20 x 20 x 2	1,13	80 x 80 x 8	16,67
25 x 25 x 2	1,45	90 x 90 x 4	10,68
25 x 25 x 3	1,99	100 x 100 x 3	9,19
30 x 30 x 2	1,77	100 x 100 x 4	11,96
30 x 30 x 3	2,47	100 x 100 x 5	14,68
35 x 35 x 2	2,09	100 x 100 x 8	21,79
35 x 35 x 3	2,95	100 x 100 x 10	25,37
40 x 40 x 2	2,41	120 x 120 x 4	14,52
40 x 40 x 3	3,43	120 x 120 x 5	17,88
40 x 40 x 4	4,28	120 x 120 x 6	21,15
45 x 45 x 2	2,73	120 x 120 x 8	26,91
45 x 45 x 3	3,91	140 x 140 x 5	21,08
50 x 50 x 2	3,05	140 x 140 x 6	24,99
50 x 50 x 3	4,39	140 x 140 x 10	42,16
50 x 50 x 4	5,56	150 x 150 x 4	18,36
50 x 50 x 5	6,68	150 x 150 x 5	22,68
60 x 60 x 2	3,69	150 x 150 x 6	26,91
60 x 60 x 3	5,35	150 x 150 x 10	41,37
60 x 60 x 4	6,84	160 x 160 x 5	22,29
60 x 60 x 5	8,28	180 x 180 x 8	42,27
70 x 70 x 3	6,31	200 x 200 x 6	36,51
70 x 70 x 4	8,12	200 x 200 x 8	47,39
80 x 80 x 3	7,27	200 x 200 x 10	57,37
80 x 80 x 4	9,40		

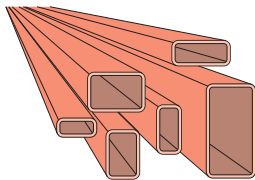

Tubes rectangulaires

Dimensions en mm	Poids Kg/m	Dimensions en mm	Poids Kg/m
20 x 10 x 1	0,44	80 x 50 x 4	7,47
30 x 15 x 2	1,29	80 x 60 x 3	6,30
30 x 20 x 2	1,45	100 x 40 x 3	6,30
30 x 20 x 3	1,98	100 x 40 x 4	8,11
40 x 20 x 2	1,77	100 x 50 x 3	6,78
40 x 20 x 3	2,46	100 x 50 x 4	8,75
40 x 30 x 2	2,09	100 x 50 x 5	10,68
50 x 20 x 2	2,09	100 x 60 x 3	7,26
50 x 25 x 2	2,25	100 x 60 x 4	9,39
50 x 25 x 3	3,18	100 x 80 x 4	10,67
50 x 30 x 2	2,41	120 x 40 x 3	7,26
50 x 30 x 3	3,42	120 x 60 x 3	8,22
50 x 40 x 2	2,73	120 x 60 x 4	10,67
50 x 40 x 3	3,90	140 x 70 x 5	15,48
60 x 20 x 2	2,41	150 x 50 x 3	9,18
60 x 30 x 2	2,73	150 x 50 x 4	11,95
60 x 30 x 3	3,90	150 x 50 x 5	14,68
60 x 40 x 2	3,05	150 x 75 x 4	14,40
60 x 40 x 3	4,38	150 x 100 x 4	15,15
60 x 50 x 3	4,86	150 x 100 x 5	18,68
70 x 30 x 3	4,20	160 x 80 x 4	14,51
70 x 40 x 3	4,86	160 x 80 x 5	17,88
70 x 40 x 4	6,19	180 x 100 x 6	26,88
80 x 40 x 2	3,69	200 x 100 x 4	18,35
80 x 40 x 3	5,34	200 x 100 x 5	22,48
80 x 50 x 3	5,82	400 x 200 x 8	76,80

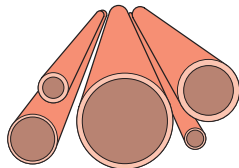

Tubes ronds soudés

Dimensions en mm	Poids Kg/m	Dimensions en mm	Poids Kg/m
17,2 x 1,8mm (3/8")	0,67	139,7 x 6,3mm	20,10
21,3 x 2mm (1/2")	0,95	152,4 x 4mm	14,60
26,9 x 2,3mm (3/4")	1,41	159 x 4,5mm	17,10
33,7 x 2,5mm (1")	2,01	159 x 6,3mm	23,70
42,4 x 2,5mm (1" 1/4)	2,58	168,3 x 4,5mm	18,18
48,3 x 2,90mm (1" 1/2)	3,25	168,3 x 6,3mm	25,30
60,3 x 2,90mm (2")	4,10	177,8 x 4,5mm	19,22
76,1 x 2,9mm	5,23	193,7 x 4mm	18,70
76,1 x 3,2mm (2" 1/2)	5,85	193,7 x 6,3mm	29,10
88,9 x 3mm	6,36	219,1 x 4,5mm	23,80
88,9 x 3,2mm (3")	6,76	219,1 x 6,3mm	33,10
101,6 x 3,6mm (3" 1/2)	8,70	244,5 x 6,3mm	37,10
114,3 x 3,6mm (4")	9,82	273 x 6,3mm	41,44
114,3 x 4mm	10,90	323,9 x 5,6mm	44,00
133 x 4mm	12,70	323,9 x 6,3mm	49,30
127 x 4mm	12,10	355,6 x 5,6mm	48,30
139,7 x 4mm	13,39	355,6 x 6,3mm	54,30

Tubes ronds ISO moyens noirs & Tubes galvanisés

Dimensions en mm	Poids Kg/m	Dimensions en mm	Poids Kg/m
10,2 x 2mm (1/8)	0,40	33,7 x 3,2mm (1")	2,44
13,5 x 2,3mm (1/4)	0,65	42,4 x 3,2mm (1" 1/4)	3,14
17,2 x 2,3mm (3/8")	0,85	48,3 x 3,2mm (1" 1/2)	3,61
21,3 x 2,6mm (1/2")	1,22	60,3 x 3,6mm (2")	5,10
26,9 x 2,6mm (3/4")	1,58		

Moulurés à Froid

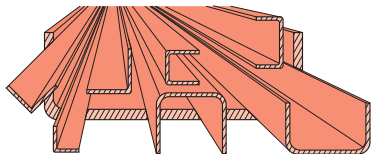

"L" CORNIÈRES		"U" ÉGAUX		"U" INÉGAUX	
Dimensions mm	Kg/m	Dimensions mm	Kg/m	Dimensions mm	Kg/m
20 x 20 x 2	0,59	20 x 20 x 2	0,85	40 x 20 x 3	1,68
25 x 25 x 2	0,75	25 x 25 x 2	1,09	40 x 30 x 3	2,16
30 x 30 x 2	0,91	30 x 30 x 2	1,33	50 x 30 x 3	2,40
40 x 40 x 3	1,80	30 x 30 x 3	1,92	60 x 30 x 3	2,64
50 x 30 x 3	1,80	40 x 40 x 2	1,81	60 x 40 x 3	3,12
50 x 50 x 3	2,28	40 x 40 x 3	2,64	70 x 40 x 3	3,36
60 x 40 x 3	2,28	50 x 50 x 3	3,36	80 x 40 x 3	3,60
60 x 60 x 3	2,76	50 x 50 x 4	4,38	80 x 50 x 3	4,08
100 x 50 x 3	3,48	60 x 60 x 3	4,08	100 x 50 x 3	4,56
		60 x 60 x 4	5,34	100 x 50 x 4	5,98
				120 x 50 x 4	6,62
				120 x 60 x 4	7,26
				140 x 60 x 4	7,90
				150 x 50 x 5	9,34
				160 x 60 x 4	8,54
				180 x 60 x 4	9,18
				200 x 60 x 4	9,82

Fontes trottoir (12 tonnes)

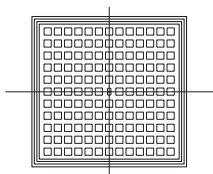
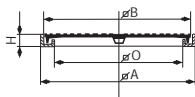

Regard pour trottoir

Type = A	O	H	B
mm	mm	mm	mm
□ 300	235	23	284
□ 400	330	30	387
□ 500	400	50	481
□ 600	500	50	580
□ 700	600	50	680
□ 800	700	50	785
□ 900	800	50	890

Résistance : > 10 Tonnes

Revêtement : goudron

Exécution avec barrette de levage

Fontes de bâtiment

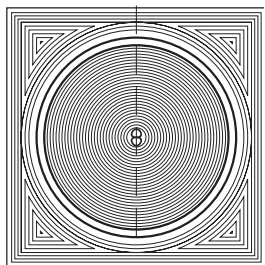
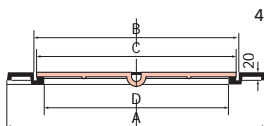
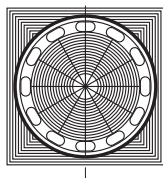
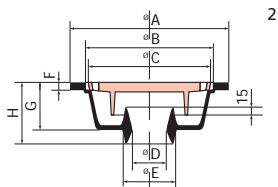
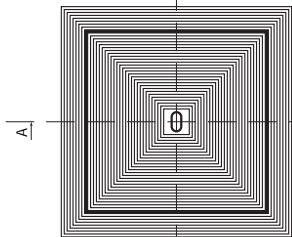
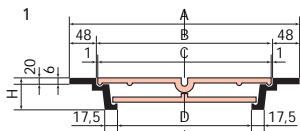

Double fond carré			Châssis simple fond		
A cm	B cm	ep' cm	A cm	B cm	ep' cm
30 x 30	20 x 20	8	30 x 30	20 x 20	2
40 x 40	30 x 30	8	40 x 40	30 x 30	2
50 x 50	40 x 40	8	50 x 50	40 x 40	2
60 x 60	50 x 50	8	60 x 60	50 x 50	2
70 x 70	60 x 60	8	70 x 70	60 x 60	2
80 x 80	70 x 70	8	80 x 80	70 x 70	2

Double fond rectangulaire			Siphon à cloche		
A cm	B cm	ep' cm	A cm	B cm	ep' cm
40 x 25	30 x 15	9	15 x 15	12,5	9
50 x 30	40 x 20	8	20 x 20	16,5	10
60 x 45	50 x 35	8	20 x 25	21,5	12
80 x 60	70 x 50	8	30 x 30	24,0	12

Châssis de cave 1/2 lune			Châssis de citerne		
A cm	B cm	ep' cm	A cm	B cm	ep' cm
50	32		50 x 50	40	2
55	35		55 x 55	45	2
60	38		60 x 60	50	2

Fontes de voirie (20 tonnes)

Avaloir

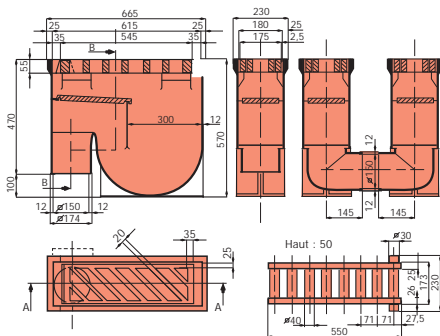

Ouverture

615 x 180 mm

Sortie

ø 150 mm verticale ou latérale

Grille

En fonte normale ou nodulaire

Barreaux

Ronds ou obliques

Coupe-air

Fontes de voirie (25 tonnes)

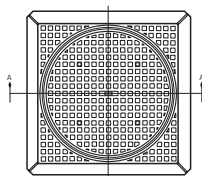
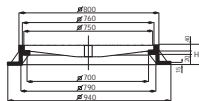

Trapillon chaussée

Ouverture : Ø 700 mm

Hauteur : 120 - 180 - 230 cm

Cadre et couvercle en fonte

H du cadre	Résist. en tonnes	Poids		
		Cadre	Couv.	Total
120	10 T.	100 kg	63 kg	163 kg
120	20 T.	100	80	180
120	40 T.	100	130	230
180	10 T.	120	63	183
180	20 T.	120	80	200
180	40 T.	120	130	250
230	10 T.	170	63	233
230	20 T.	170	80	250
230	40 T.	170	130	300
230	10 T.	200	63	163
230	20 T.	200	80	280
230	40 T.	200	130	330

Couvercle en Fonte Nodulaire

120	25 T.	100 kg	63 kg	163 kg
120	40 T.	100	80	180
180	40 T.	120	80	200
230	40 T.	170	80	250
230	40 T.	200	80	280

Caillebotis

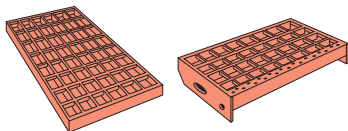

Dimensions extérieures du plancher	Barres portantes	Hauteur x épaisseur
600 x 600	25 x 2	Panneaux standards industriels
600 x 1000	25 x 2	
700 x 1000	25 x 2	
800 x 1000	25 x 2	
900 x 1000	25 x 2	
1000 x 1000	30 x 2	
1250 x 1000	30 x 2	
1500 x 1000	30 x 3	Panneaux standards
500 x 350	20 x 2	
600 x 400	20 x 2	
600 x 400	25 x 2	
800 x 500	20 x 2	
800 x 500	25 x 2	
800 x 800	25 x 2	
1000 x 400	25 x 2	
1000 x 500	25 x 2	
500 x 1000	25 x 2	
1000 x 600	30 x 2	
1200 x 500	30 x 2	
1200 x 600	30 x 2	
600 x 200	25 x 2	Marches standards
700 x 240	30 x 2	
800 x 240	30 x 2	
900 x 240	40 x 2	
1000 x 240	40 x 2	
1200 x 240	40 x 2	
240 x 1000	25 x 3	Planchers standards

Dimensions en mm.

Fabrication sur mesure à la demande.

Outillages de chantier

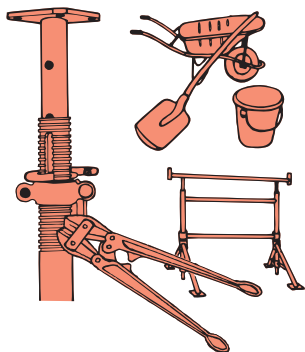

Cintreuse - Disque à découper et à meuler - Baguette à souder - Peinture anti-rouille (2,5 litres et 5 litres) - Peinture Zinga - Matériel ROB

Scellements chimiques

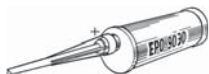

Cartouche



Mixer



Pistolet mécanique

Barrières de chantier

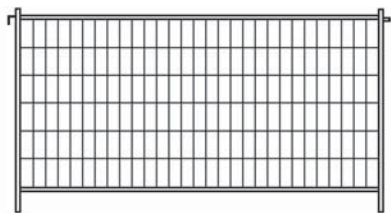

Largeur : 3,5 m
Hauteur : 2 m



Pied en béton
22 x 62 cm



Collier de sécurité

Armatures pour maçonneries galvanisées

Largeur A	Ø mm	p/Box	Kg/pièce
50	4	25	0,54
100	4	25	0,56
150	4	25	0,58
200	4	25	0,60

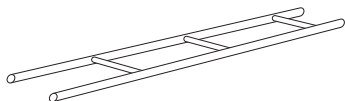

Longueur : 2,70 m

Linteaux

Linteaux - Acier galvanisé

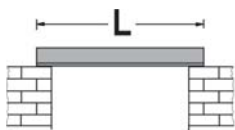

L cm	Ep mm	Kg/pce
100	3	3,36
120	3	4,03
140	4	6,27
160	4	7,17
180	4	9,50
200	4	10,56
220	4	11,62
240	4	12,67
260	4	18,30
280	4	19,71
300	4	21,12
320	4	22,53
340	4	23,94

Cornières KORBO



Visibles et non-visibles + crochets.

Finitions Galva - Inox.

Sur demande.

Boulonnerie



Boulons expansibles zingués

M	Lmm	p/Box
M8	75	50
M10	100	25
M12	85	25
M12	100	25
M12	145	25
M16	125	10
M16	175	10

Boulonnerie M6 à M30 - acier zingué

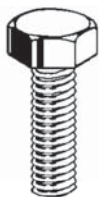

Tiges filetées - clous

Sièges Social, Administratif et Magasins

Rue de la Croix du Maïeur 26

B-7110 Strepy-Bracquegnies

Tél : +32.(0)64.22.23.16 - +32.(0)64.22.23.17

Fax : +32.(0)64.21.69.51

E-mail : info@masquelieraciers.be

www.masquelieraciers.be

TVA : BE 0401.772.614

IBAN : BE58 7320 1580 4179

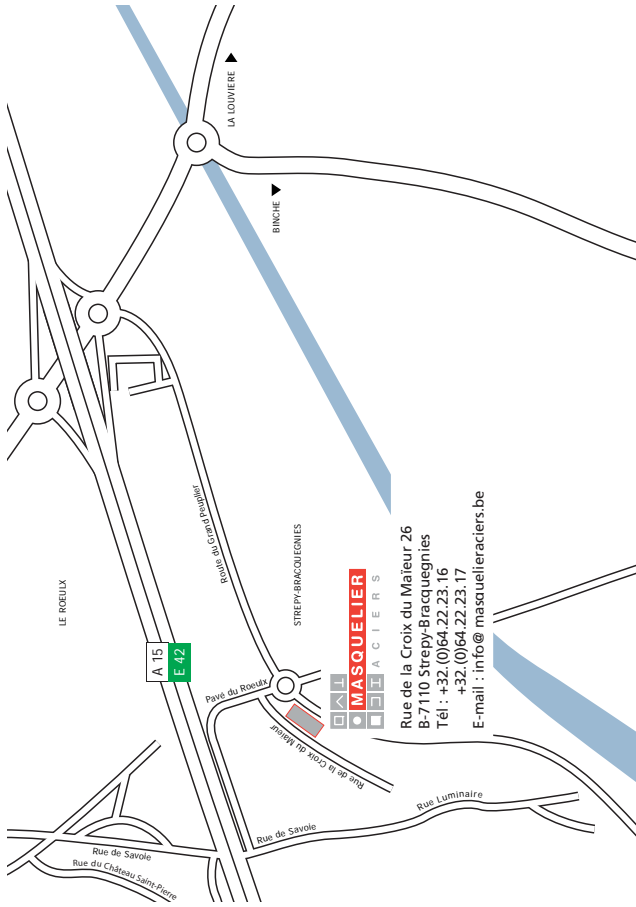

LE ROEULX

LA LOUVIERE ▲

BINCHE ▼

Route du Grand Trouglier

STREY-BRACQUEGNIES

A 15
E 42

Pave du Roeulx



Rue de la Croix du Mateur 26
B-7110 Strey-Bracquegnies
Tél : +32.(0)64.22.23.16
+32.(0)64.22.23.17
E-mail : info@masquelieraciers.be

Rue de Savoie
Rue du Château Saint-Pierre

Rue de Savoie

Rue Luminaire